

# Euro gauge

## Liquid filled industrial pressure gauge (Internal brass)

### Model : P259 series

Spec. sheet no. PD02-14

#### Service intended

P259 series are designed for long and reliable service under rugged conditions. P259 series are intended for adverse service conditions where pulsating or vibration exists, Hydraulic & compressors and are suitable for gaseous or liquid media that will not obstruct.

#### Nominal diameter

63, 100 and 160 mm

#### Accuracy

P2592 (63 mm) :  $\pm 1.6$  % of full scale

P2594 (100 mm) and P2596 (160 mm) :  $\pm 1.0$  % of full scale

#### Scale range (MPa, kPa, bar)

63 mm : -0.1 ~ 0 to 0 ~ 40 MPa

100 and 160 mm : -0.1 ~ 0 to 0 ~ 100 MPa

#### Filling liquid

Glycerine

#### Working pressure

Steady : 75 % of full scale (63 mm)

100 % of full scale (100 and 160 mm)

Over range protection : 130 % of full scale

#### Working temperature

Ambient : -20 ~ 60 °C (With glycerin filling)

-40 ~ 60 °C (With silicone filling)

Fluid : Max. 60 °C

#### Degree of protection

EN60529/IEC529/IP67

#### Temperature effect

Accuracy at temperature above and below the reference temperature (20 °C) will be effected by approximately  $\pm 0.4$  % per 10 °C of full scale



### Standard features

#### Pressure connection

Brass

#### Element

Brass

Model : P2594 (100 mm) and P2596 (160 mm)

<10 MPa : C type bourdon tube

$\geq 10$  MPa : Helical type bourdon tube with 316SS

Model : P2592 (63 mm)

<6 MPa : C type bourdon tube

$\geq 6$  MPa : Helical type bourdon tube

#### Blowout protection

Back, Rubber disc for 100 and 160 mm

Top, Rubber disc for 63 mm

#### Case

Stainless steel (304SS)

#### Cover

Stainless steel (304SS)

Bayonet type

#### Window

Laminated safety glass

#### Movement

63 mm : Brass

100 and 160 mm : Stainless steel

#### Dial

White aluminium with black graduations

#### Pointer

Black painted aluminium alloy

#### Process connection

63 mm :  $\frac{1}{4}$ " PT, NPT and PF

100 and 160 mm :  $\frac{3}{8}$ ",  $\frac{1}{2}$ " PT, NPT and PF

#### Option

Zero adjustable pointer

(Only available with diameter 100 and 160 mm)

Silicone filling

**WISE**<sup>®</sup>

**1. Base model**

**P259** Liquid filled industrial pressure gauge (Internal brass)

**2. Nominal diameter (mm)**

2 63  
4 100  
6 160

**3. Type of mounting**

**A** Bottom connection, direct  
**B** Bottom connection, surface, case mounting plate  
**F** Center back connection, direct, only available with diameter 63 mm  
**G** Lower back connection, direct, only available with diameter 100 mm  
**H** Center back connection, flush, case center mounting plate, only available with diameter 63 mm  
**I** Center back connection, flush, case center mounting plate with bracket, only available with diameter 63 mm  
**J** Center back connection, flush, cover mounting plate, only available with diameter 63 mm  
**L** Lower back connection, flush, case center mounting plate, only available with diameter 100 mm  
**M** Lower back connection, flush, case center mounting bracket, only available with diameter 100 mm  
**N** Lower back connection, flush, cover mounting plate, only available with diameter 100 mm  
**V** Center back connection, flush, cover mounting bracket, only available with diameter 63 mm  
**W** Lower back connection, flush, cover mounting bracket, only available with diameter 100 mm

**4. Accuracy**

**3** ±1.0 % of full scale, not available with diameter 63 mm  
**4** ±1.6 % of full scale, only available with diameter 63 mm

**5. Process connection**

**C** ¼"  
**D** ⅜", not available with diameter 63 mm  
**E** ½", not available with diameter 63 mm

**6. Connection type**

**B** PF  
**C** PT  
**D** NPT  
**F** BSPT  
**G** BSP (G)  
**Z** Other

**7. Unit**

**H** bar  
**I** MPa  
**J** kPa  
**Z** Other

**8. Range**

**XXX** Refer to pressure unit and range table

**9. Dial color**

**1** 2 colors  
**5** 3 colors

**10. Option**

**0** None  
**1** Accessories  
**2** Silicone filling  
**3** Accessories and silicone filling

1	2	3	4	5	6	7	8	9	10
P259	4	A	3	C	D	H	XXX	5	0

Sample  
ordering code

## P259 : Type of mounting (1/2)

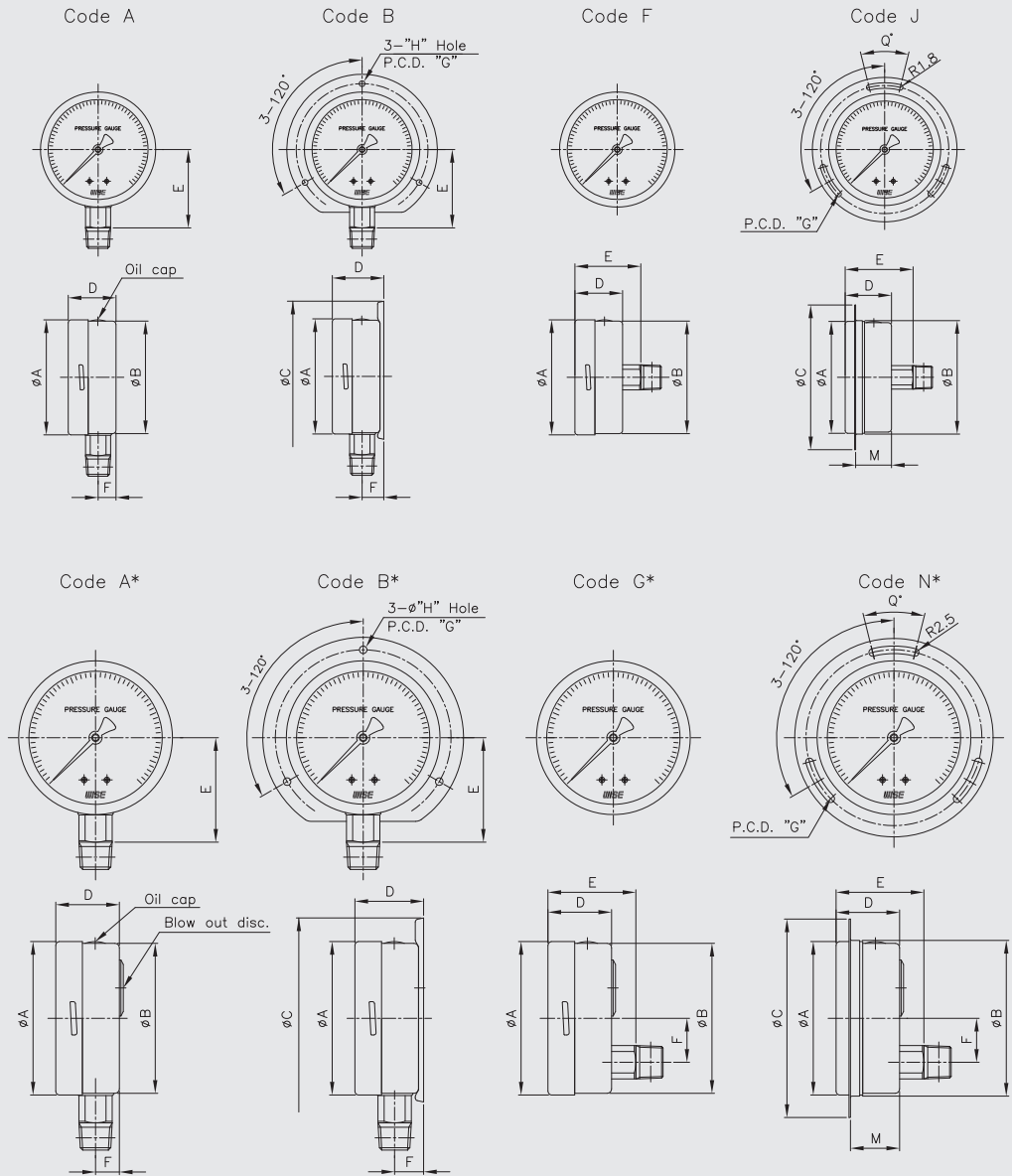

Dimensions (mm)

Dial size	Available code	A	B	C	D±2	E±2	F±1	M	G	H	Q
63	A	64	62		34	41.7	11				
	B	64		85	37	41.7	15		74~75	R2.1	
	F	64	62		34	45					
	J	64	66	86	34	45		28	75		15
100	A*	101.3	99		50	65	16				
	B*	101.3		133	54.4	65	19.4		115~116	R2.5	
	C*	101.3	99		50	65	29				
	N*	101.3	103.1	130.5	50	65	29	45	116		28
160	A*	160.6	159		52.5	94	15.8				
	B*	160.6		196	56	94	19.3		178	5.8	

## P259 : Type of mounting (2/2)

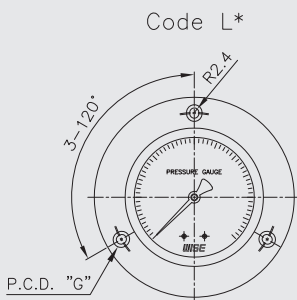
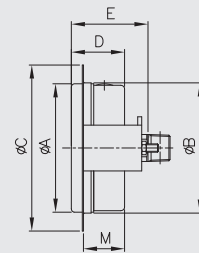
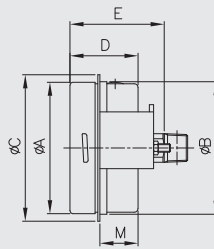
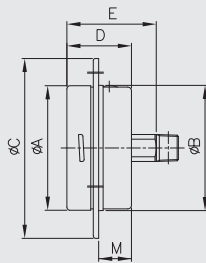
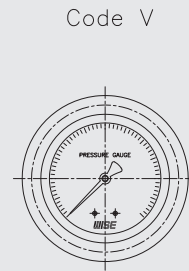
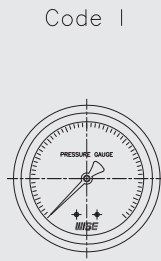
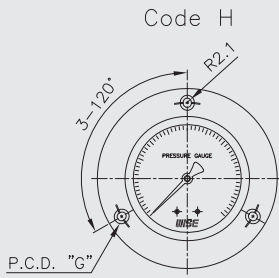

Code M\*

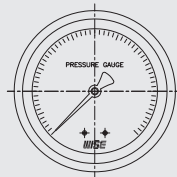

Code W\*

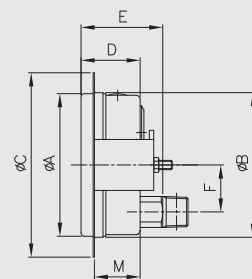
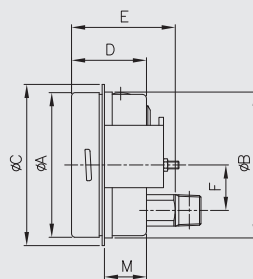
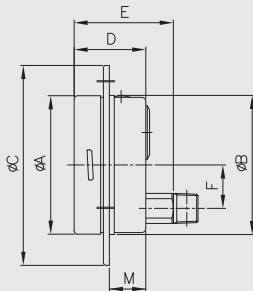
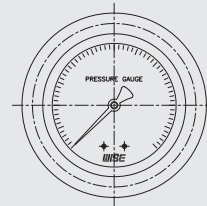

Dimensions (mm)

Dial size	Available code	A	B	C	D $\pm 2$	E $\pm 2$	F $\pm 1$	M	G
63	H	64	64.5	92	34	45			77~78
	I	64	63.7	71	34	45		18.5	
	V	64	66	86	34	45		28	
100	L*	101.3	100.4	132	50	65	29	27.7	115~116
	M*	101.3	101	107.5	50	65	29	29.5	
	W*	101.3	103.1	130.5	50	65	29	45	

## Pressure unit and range table

Range and code	Unit and code			Nominal diameter		
	H : bar	I : MPa	J : kPa	63 mm	100 mm	160 mm
026	-1 ~ 0	-0.1 ~ 0	-100 ~ 0	O	O	O
041	0 ~ 1	0 ~ 0.1	0 ~ 100	O	O	O
133	0 ~ 1.6	0 ~ 0.16	0 ~ 160	O	O	O
042	0 ~ 2	0 ~ 0.2	0 ~ 200	O	O	O
134	0 ~ 2.5	0 ~ 0.25	0 ~ 250	O	O	O
043	0 ~ 3	0 ~ 0.3	0 ~ 300	O	O	O
044	0 ~ 4	0 ~ 0.4	0 ~ 400	O	O	O
045	0 ~ 6	0 ~ 0.6	0 ~ 600	O	O	O
047	0 ~ 10	0 ~ 1	0 ~ 1,000	O	O	O
050	0 ~ 15	0 ~ 1.5	X	O	O	O
143	0 ~ 16	0 ~ 1.6	X	O	O	O
051	0 ~ 20	0 ~ 2	X	O	O	O
052	0 ~ 25	0 ~ 2.5	X	O	O	O
054	0 ~ 35	0 ~ 3.5	X	O	O	O
151	0 ~ 40	0 ~ 4	X	O	O	O
055	0 ~ 50	0 ~ 5	X	O	O	O
056	0 ~ 60	0 ~ 6	X	O	O	O
057	0 ~ 70	0 ~ 7	X	O	O	O
058	0 ~ 100	0 ~ 10	X	O	O	O
059	0 ~ 150	0 ~ 15	X	O	O	O
060	0 ~ 160	0 ~ 16	X	O	O	O
062	0 ~ 250	0 ~ 25	X	O	O	O
064	0 ~ 350	0 ~ 35	X	O	O	O
065	0 ~ 400	0 ~ 40	X	O	O	O
066	0 ~ 500	0 ~ 50	X	X	O	O
067	0 ~ 600	0 ~ 60	X	X	O	O
068	0 ~ 700	0 ~ 70	X	X	O	O
070	0 ~ 1,000	0 ~ 100	X	X	O	O
027	-1 ~ 1	-0.1 ~ 0.1	-100 ~ 100	O	O	O
007	-1 ~ 1.5	-0.1 ~ 0.15	-100 ~ 150	O	O	O
028	-1 ~ 2	-0.1 ~ 0.2	-100 ~ 200	O	O	O
029	-1 ~ 3	-0.1 ~ 0.3	-100 ~ 300	O	O	O
030	-1 ~ 4	-0.1 ~ 0.4	-100 ~ 400	O	O	O
010	-1 ~ 5	-0.1 ~ 0.5	-100 ~ 500	O	O	O
031	-1 ~ 6	-0.1 ~ 0.6	-100 ~ 600	O	O	O
014	-1 ~ 9	-0.1 ~ 0.9	-100 ~ 900	O	O	O
032	-1 ~ 10	-0.1 ~ 1	-100 ~ 1,000	O	O	O
033	-1 ~ 15	-0.1 ~ 1.5	X	O	O	O
034	-1 ~ 20	-0.1 ~ 2	X	O	O	O
017	-1 ~ 24	-0.1 ~ 2.4	X	O	O	O
035	-1 ~ 25	-0.1 ~ 2.5	X	O	O	O

O : Available X : Not available

## Conversion table

### Pressure conversion chart

psi	atm	kgf/cm <sup>2</sup>	inH <sub>2</sub> O	mmHg	inHg	kPa	bar	mmH <sub>2</sub> O
1	0.068046	0.070307	27.7276	51.715	2.03602	6.835	0.06895	704.28104
14.696	1	1.0332	407.484	760	29.921	101.325	1.01325	10350.0936
14.2233	0.96784	1	394.38	735.559	28.959	98.096	0.98067	10,000
0.036092	0.002454	0.00253	1	1.8651	0.07343	0.249	0.00249	25.4
0.019336	0.001315	0.001359	0.53616	1	0.03937	0.1333	0.001333	13.618464
0.491154	0.0033421	0.03453	13.6185	25.4	1	3.3864	0.033864	345.9099
0.145	0.00987	0.010197	4.0186	7.5006	0.2953	1	0.01	102.07244
14.5038	0.98692	1.01972	402.156	750.062	29.53	100	1	10214.7624
0.00142	0.000097	0.0001	0.03937	0.0734	0.0029	0.0098	0.000098	1

### Volume conversion chart

Gallon (U.S)	Cubic feet	Cubic inches	Barrels (Oil)	Cubic cm	Cubic meter	Liter	IMP. Gallon
1	0.1337	231	0.02381	3,785	0.003785	3.785	0.8327
7.481	1	1,728	0.1781	28,320	0.02832	28.32	6.229
0.004329	0.000578	1	0.000103	16.39	0.000016	0.01639	0.003605
42	5.615	9,702	1	159,000	0.159	158.94	34.97
0.000264	0.000035	0.06102	0.000006	1	0.000001	0.001	0.00022
264.17	35.3144	61,023	6.2906	1,000,000	1	1,000	220.1
0.264	0.0353	61.03	0.0629	1,000	0.001	1	0.22
1.201	0.1606	277.4	0.0286	4,546	0.004546	4.546	1

### Mass conversion chart

lb.	oz.	kg	gm	gal H <sub>2</sub> O (32F)	Long ton	Metric tonne	ton
1	16	0.4536	453.6	0.1198	0.000446	0.000453	0.0005
0.0625	1	0.02835	28.35	0.00749	0.000027	0.000028	0.000031
2.205	35.27	1	1,000	0.2642	0.009839	0.001	0.001102
0.002205	0.03527	0.001	1	0.00264	0.000000	0.000001	0.000001
8.345	133.5	3.785	3,785	1	0.003726	0.003786	0.004171
2,240	35,840	1016.4	1,016,363	268.352	1	1.016	1.12
2,204.6	35,273	1,000	1,000,000	264.11	0.9842	1	1.1023
2,000	32,000	907.03	909,090.9	239.7	0.892857	0.907194	1

### Density conversion chart

lb / ft <sup>3</sup>	gm / cm <sup>3</sup>	ka / m <sup>3</sup>	lb / in <sup>3</sup>
1	0.016018	16.0184	0.000578
62.43	1	1,000	0.03613
0.06243	0.001	1	0.000036
1728	27.68	27,679.8	1